

## Capítulo 23 (Lift) elevar

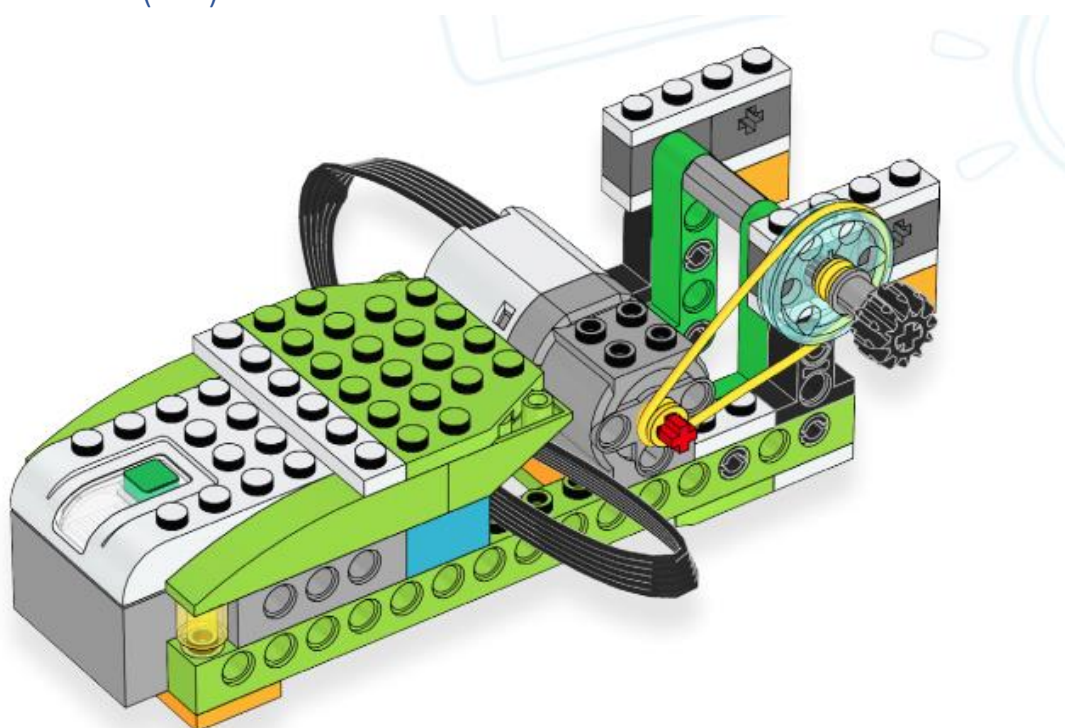

Para este capítulo necesitamos un solo Kit.

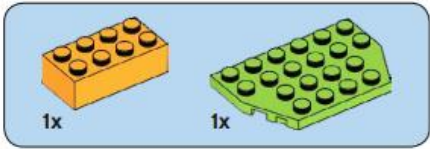

1

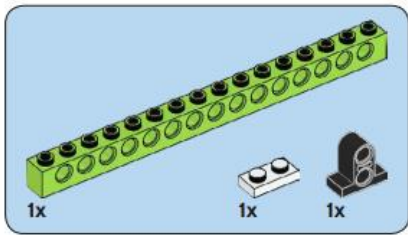
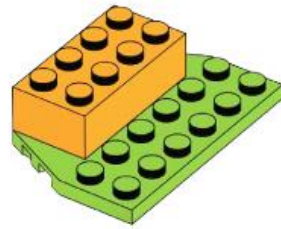

2

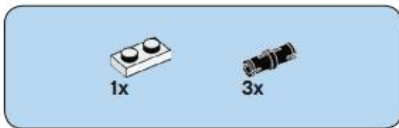
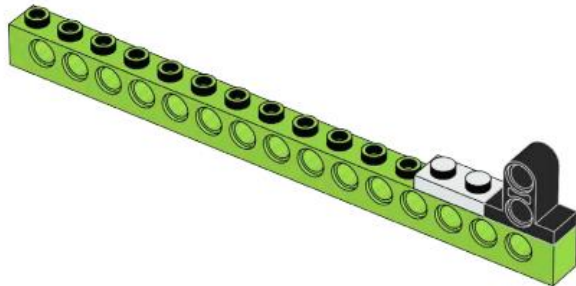

3

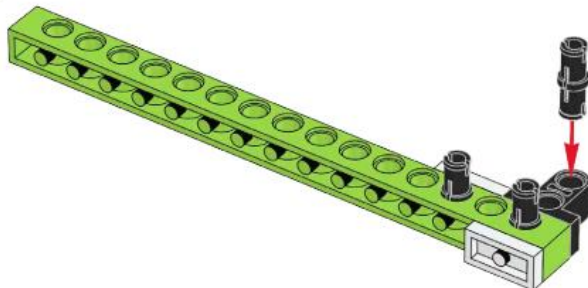

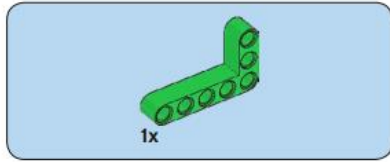

4

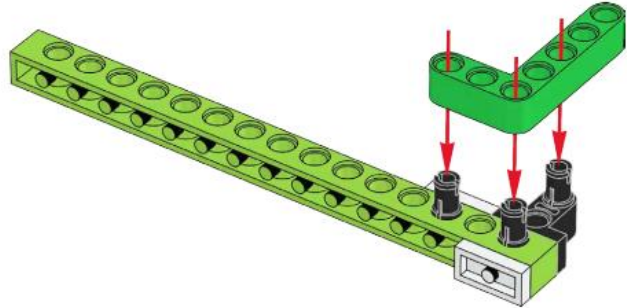

5

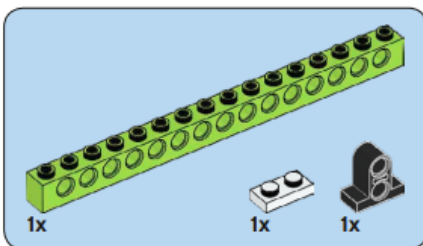
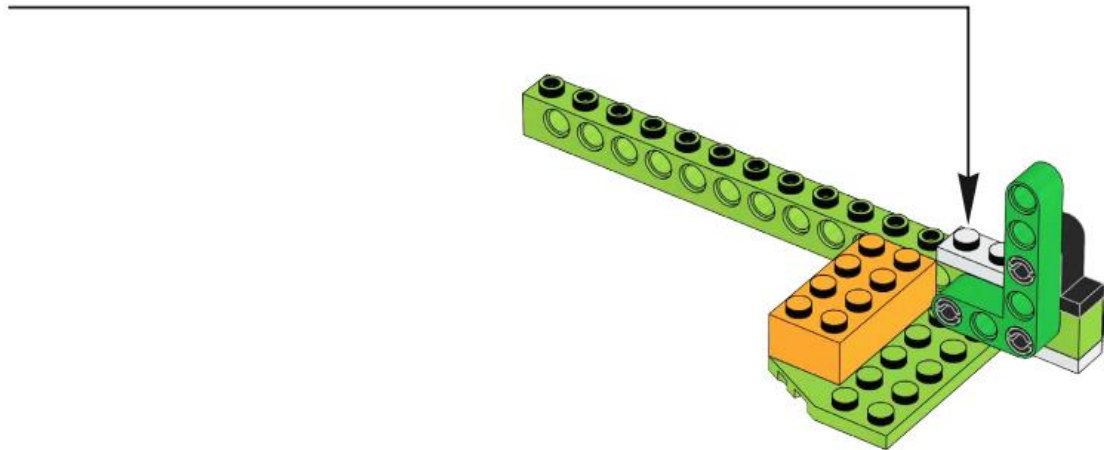

6

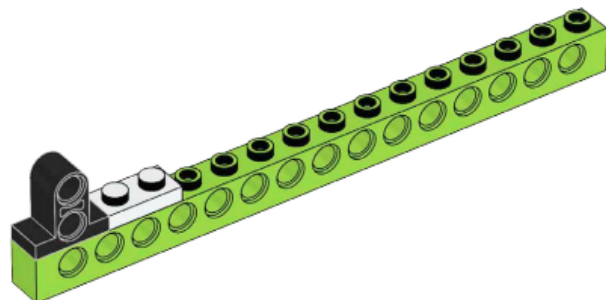

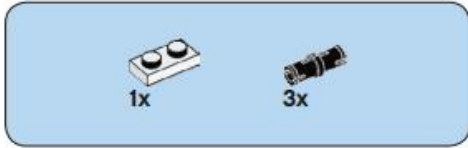

7

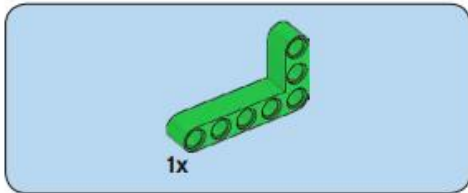
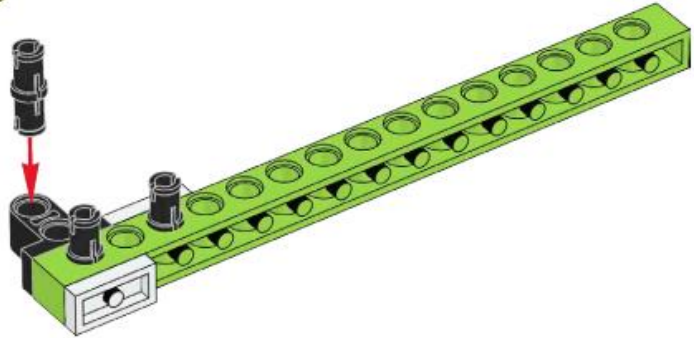

8

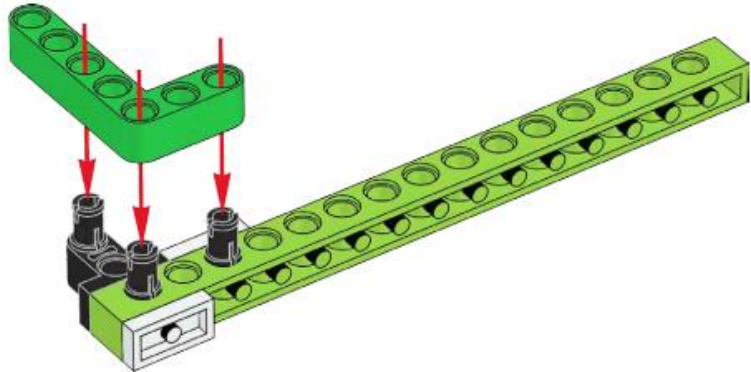

9

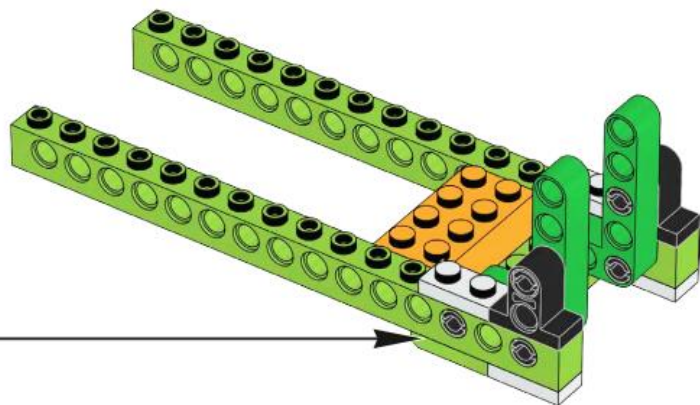

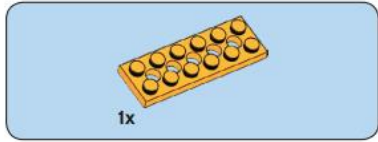

10

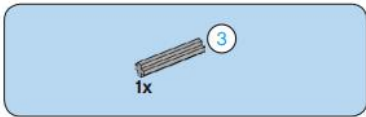
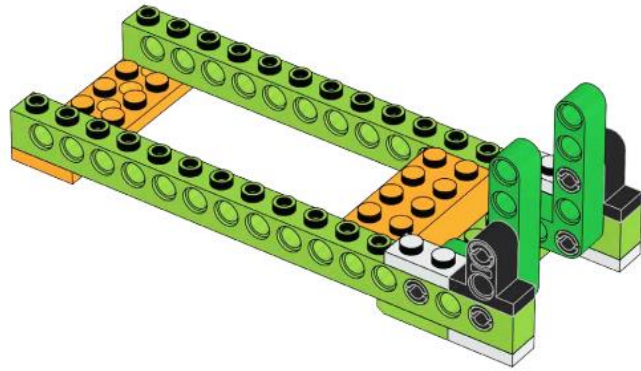

11

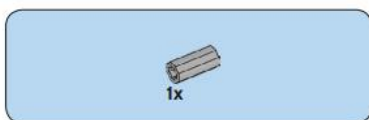
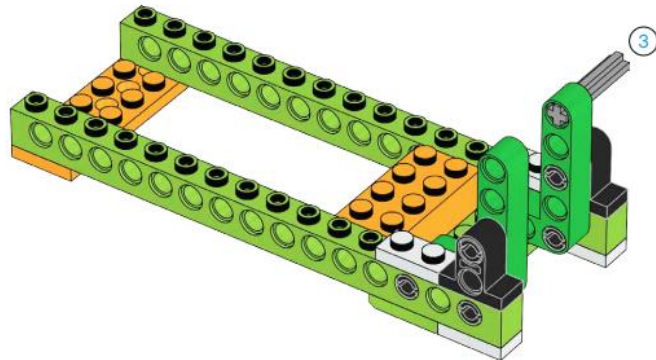

12

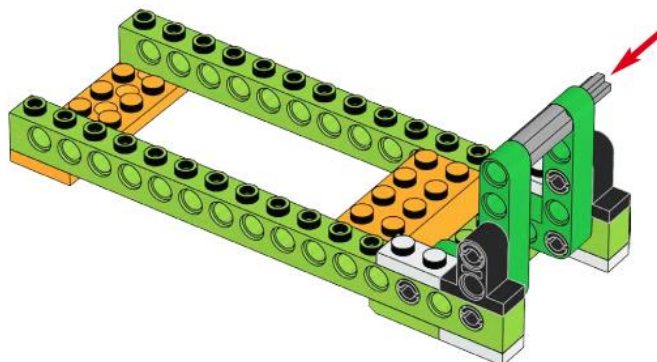



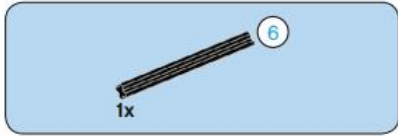

13

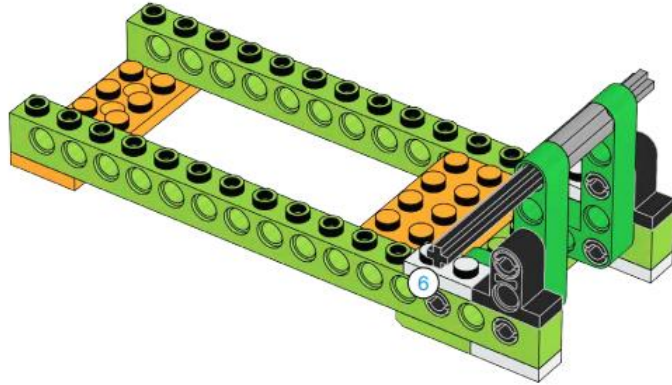

14

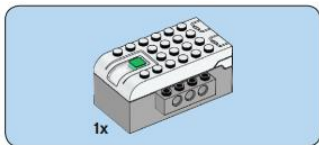
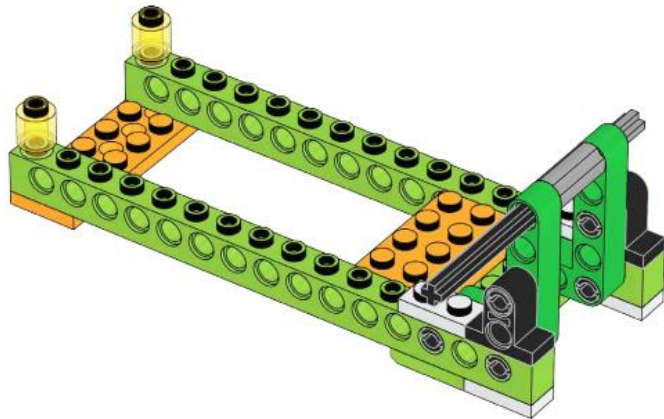

15

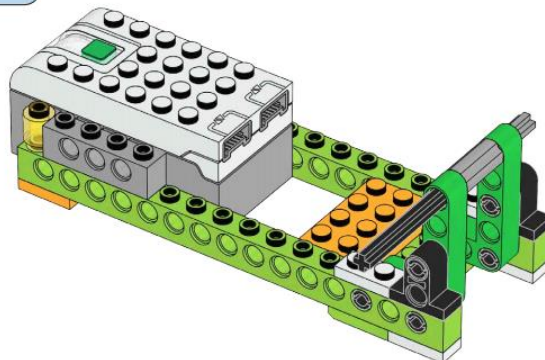



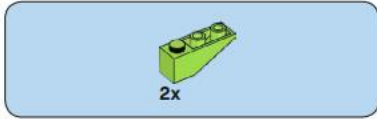

19

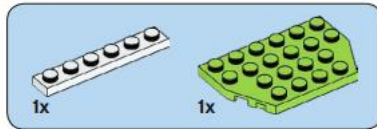
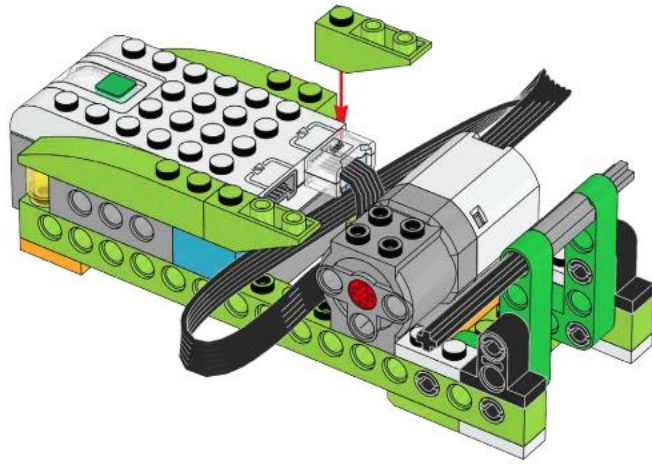

20

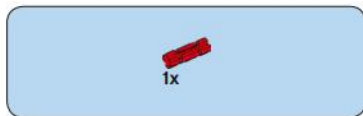
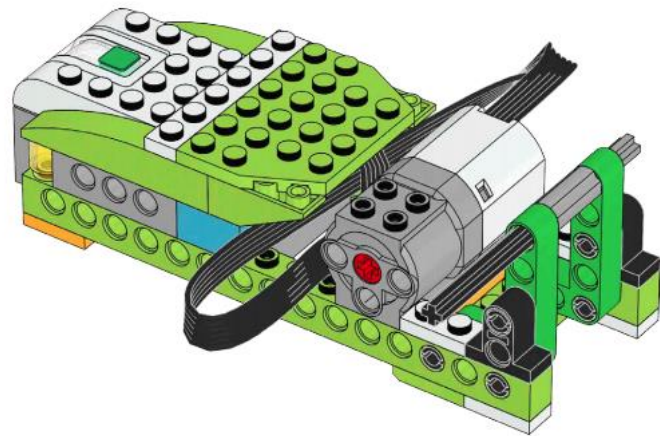

21

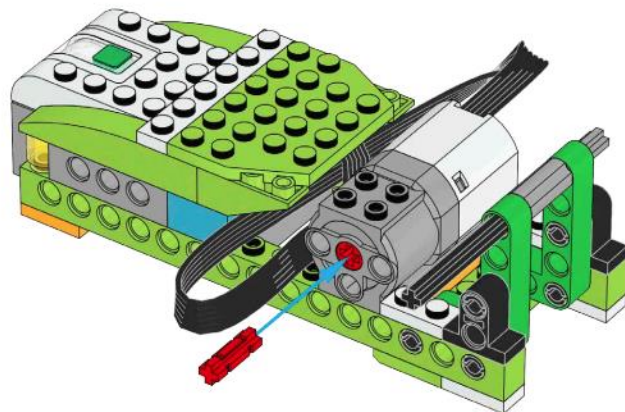





22

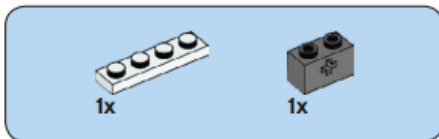
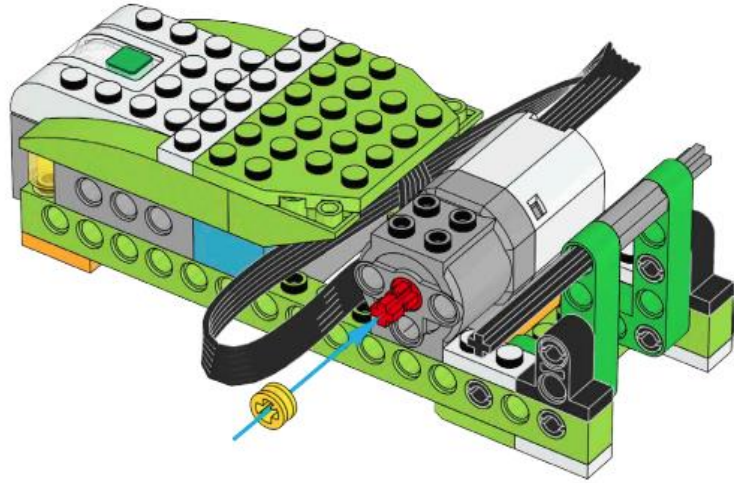

23

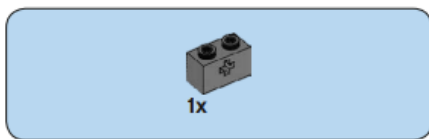
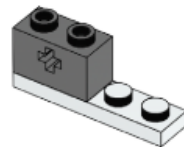

24

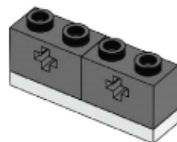

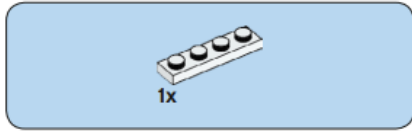

25

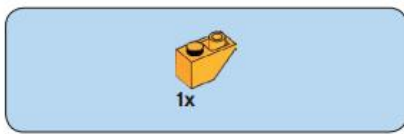
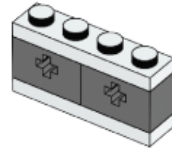

26

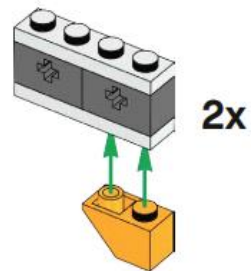

27

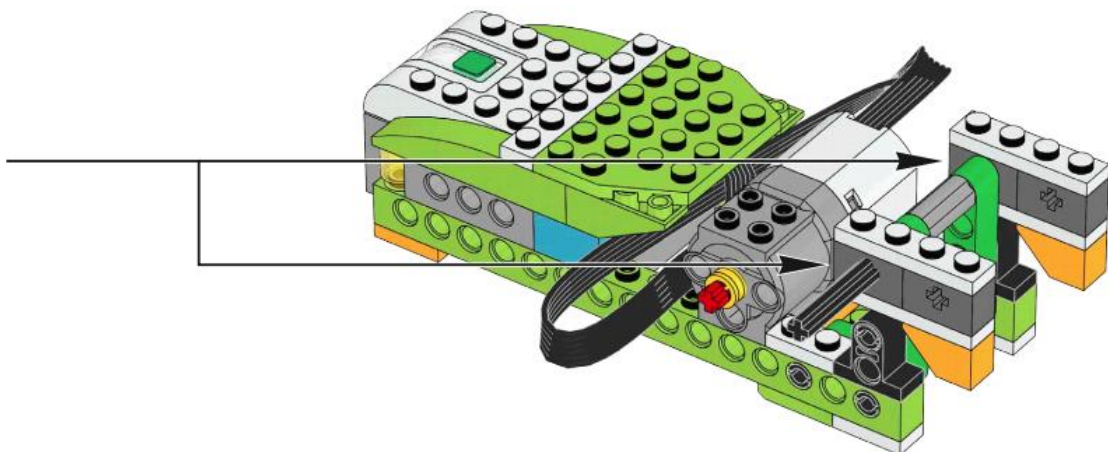

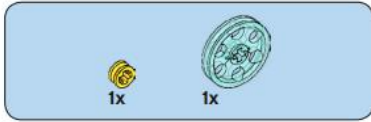

28

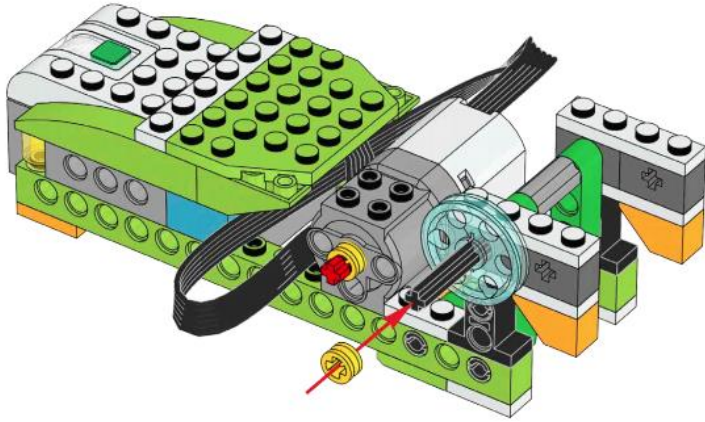

29

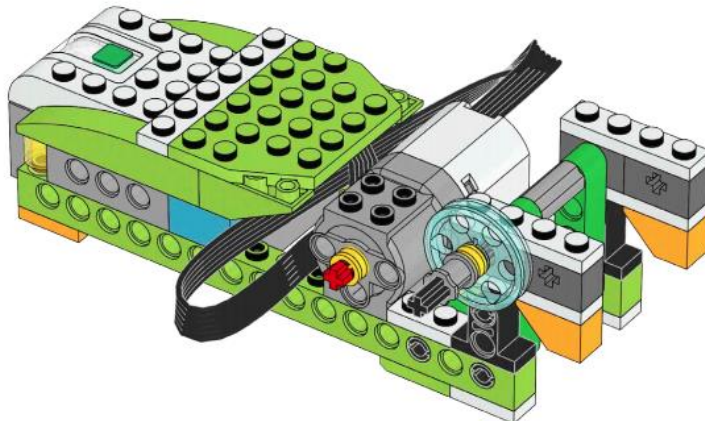

30

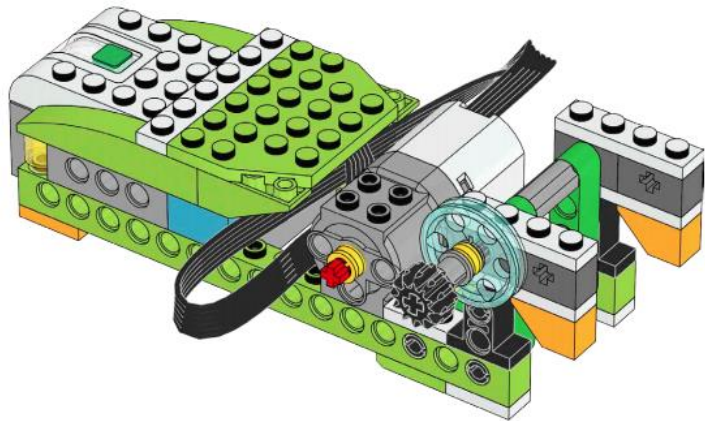

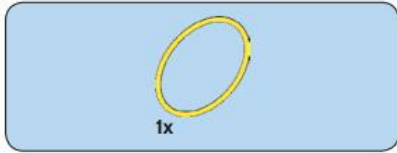

31

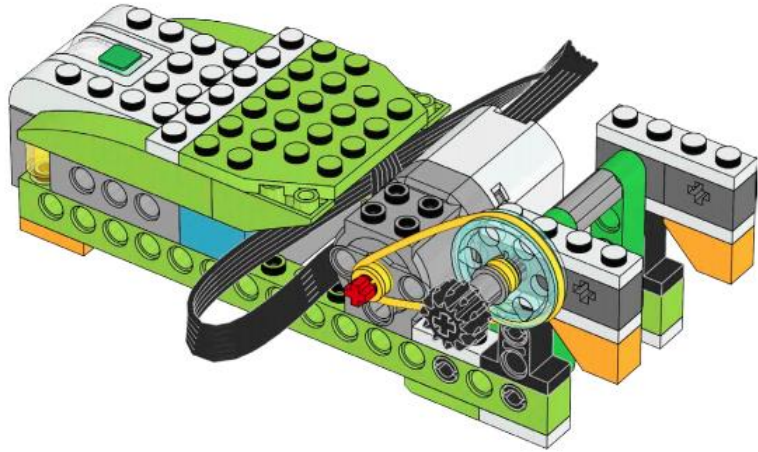

32

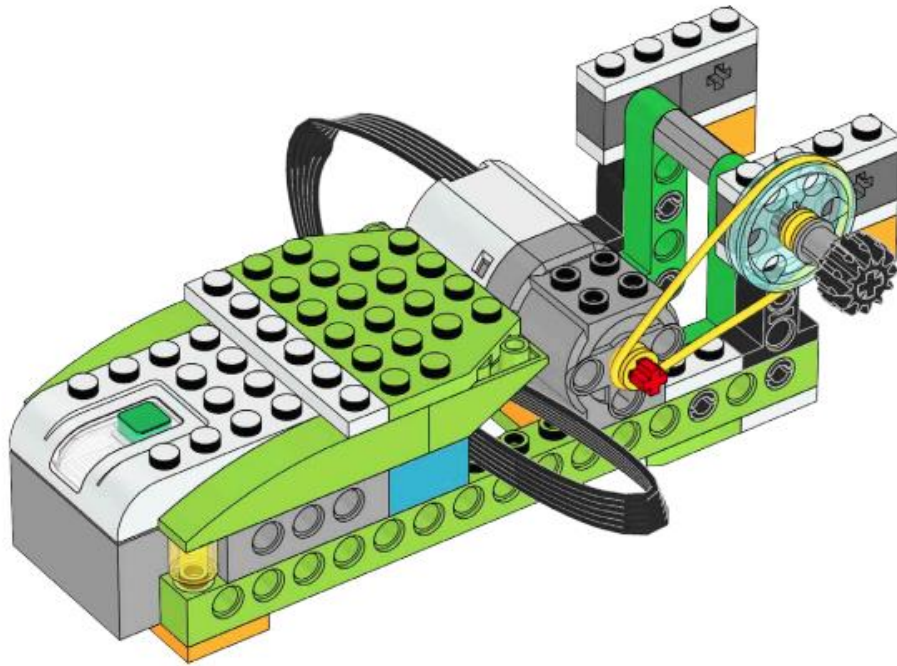

Codificación







Ahora realiza los siguientes cambios:



Este será el resultado:

